

HSF RoHS

REV	ECN NO	DESCRIPTION	DATE	NAME
A		NEW	6/1-20	HYJ

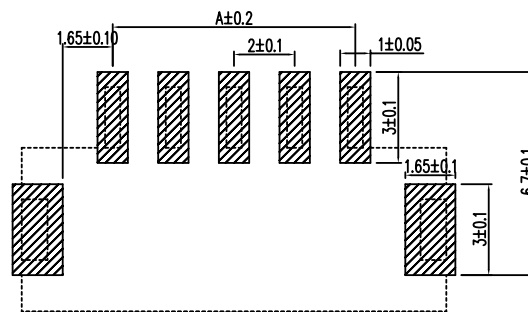

印制线路板

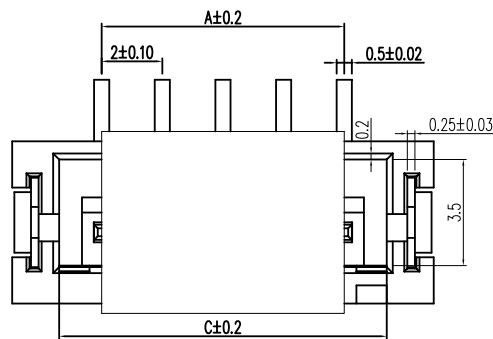
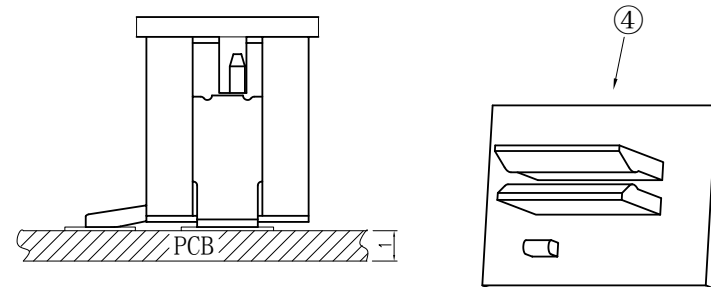
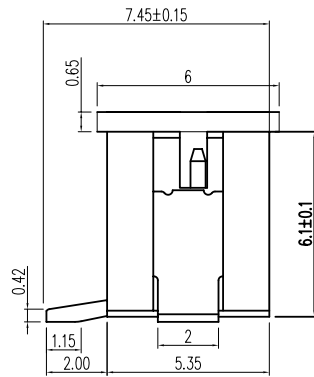
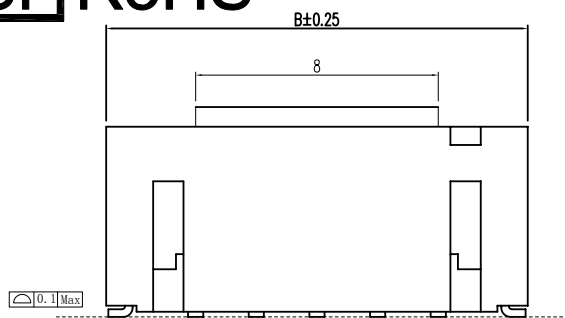
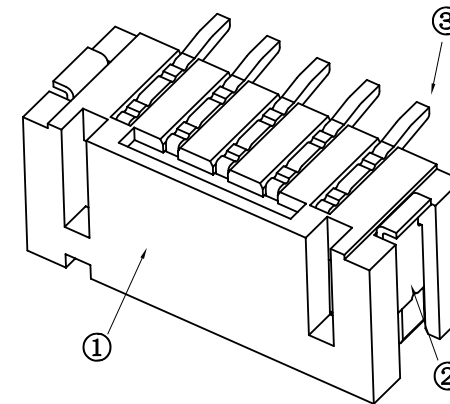

L2001AWV - ** - F2M A - * - X

PART No. ————
 No. OF CIRCUITS ———— 02~15
 PLASTIC MATERIAL ———— F2M=LCP (BEIGE)
 SPECIAL CODE: CAP
 PACKAGING
 R=REEL
 P=PE
 PLATING
 A=MATTE Sn

1. 技术参数:

- 1.1 额定电流: 2.0A AC/DC
- 1.2 额定电压: 250V
- 1.3 耐电压: 1000V ACminute
- 1.4 接触电阻: 20mΩ MAX
- 1.5 绝缘电阻: 1000MΩ MIN
- 2. 工作温度: -25℃~+85℃

Circuits	Dimensions (mm)			Circuits	Dimensions (mm)		
	A	B	C		A	B	C
2P	2.0	7.90	4.85	12P	22.0	27.9	24.85
3P	4.0	9.90	6.85	13P	24.0	29.9	26.85
4P	6.0	11.90	8.85	14P	26.0	31.9	28.85
5P	8.0	13.90	10.85	15P	28.0	33.9	30.85
6P	10.0	15.90	12.85	16P	30.0	35.9	32.85
7P	12.0	17.90	14.85	17P	32.0	37.9	34.85
8P	14.0	19.90	16.85	18P	34.0	39.9	36.85
9P	16.0	21.90	18.85	19P	36.0	41.9	38.85
10P	18.0	23.90	20.85	20P	38.0	43.9	40.85
11P	20.0	25.90	22.85				

TOLERANCE UNLESS OTHERWISE SPECIFIED	
LINER	ANGLES
.0 ±0.30	0.° ±3°
.00 ±0.20	.0° ±2°
.000 ±0.10	.00° ±1°

NO	物料名称	规格型号	数量 (PCS)	材质	镀涂
①	底座	2.0	1	LCPE130i	本色
②	焊片	2.0	2	黄铜	锡
③	插针	2.0	2~20	黄铜	锡
④	盖板	2.0	1	LCPE130i	本色

品名		连接器		图号	
LDCONN 东莞连大精密制品有限公司 DongGuan LianDa Precision Products Co., LTD					
TITLE	WAFER-L PH2.0 1XNP 立贴 带帽	DRAWN BY	HYJ	6/16-20	
PART NO	L2001AWV-**-F2MA-**-X	CHECKED BY			
DRAWING NO		APPROVED BY			
SCALE	1:1	UNIT	mm	PAGE	1/1
				SIZE	A4

标记	版本	更正记录	修订人	审核
△				
△				
△				

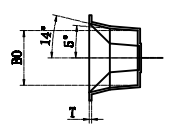
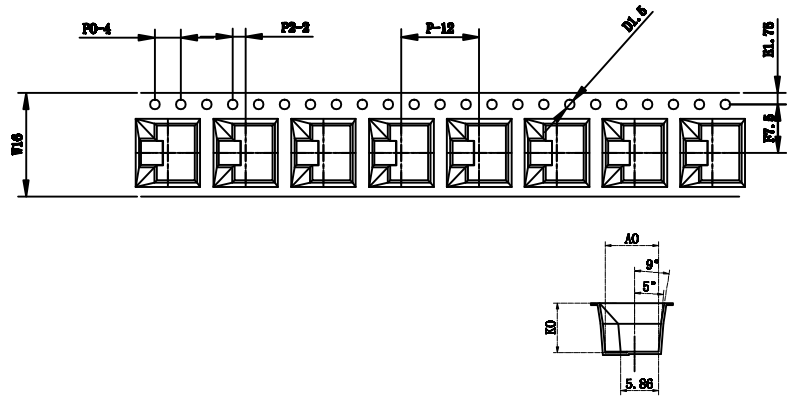

卷装示意图仅供参考

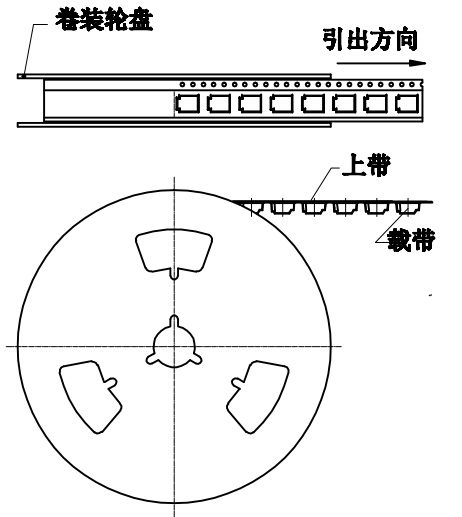

尺寸栏	
E	1.75±0.10
F	7.5±0.10
P2	2.00±0.10
∅D	1.50± $\begin{smallmatrix} 0.10 \\ 0.00 \end{smallmatrix}$
Po	4.00±0.10
W	16.00±0.30
P	12.0±0.10
Ao	8.25±0.10
B0	8.35±0.10
K0	7.65±0.10
t	0.35±0.05

A-A

生产参数	
模数	93 模
颗数	744 颗
卷轮	330mm
包装数	700 颗

- 说明
- 10个边孔的累计公差不能超过±0.2mm.
 - 材料规格: PS 白色料抗静电, 厚度 0.35mm.
 - 13英寸卷轮卷装长度; 8.928米, 包装零件总颗数; 744颗, 每盘实包颗数; 700颗
 - 所有尺寸设计参照EIA-481-C-2003.
 - 载带在250mm长度内最大弯曲不能超过1mm见上图

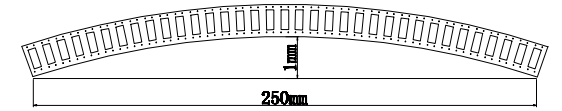

东莞连大精密制品有限公司 DongGuan LianDa Precision Products Co., LTD		产品名称: 载带	
审核		产品型号: 2.0-20-250	
日期: 2019年9月11日		客户:	单位: mm
		页码: 1/1	比例: 1:1
		版本: A0	